

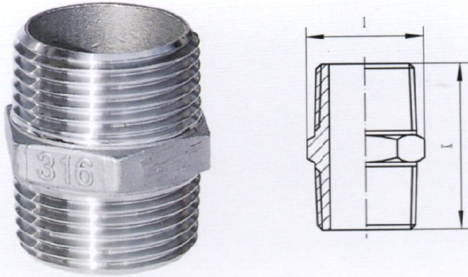

## STAINLESS STEEL FITTINGS SERIES

HEX NIPPLE



SIZE	1/8"	1/4"	3/8"	1/2"	3/4"	1"	1 1/4"	1 1/2"	2"	2 1/2"	3"	4"
I	12	14.5	18	22.5	28	35	44	50	62	78	91	116
K	29.5	28	31	33.5	38	41.5	48.5	48.5	57	67	75	81

REDUCED HEX NIPPLE

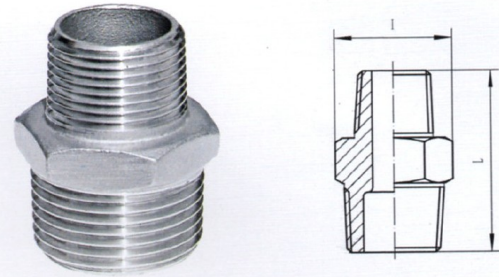

SIZE	1/8"	1/4"	3/8"	1/2"	3/4"	1"	1 1/4"	1 1/2"	2"	2 1/2"	3"	4"
I		14.5	18	22	28	35	44	50	62	79	92	118
L		28	31	37	42	47	52	56	60	70	76	82

HEX PLUG

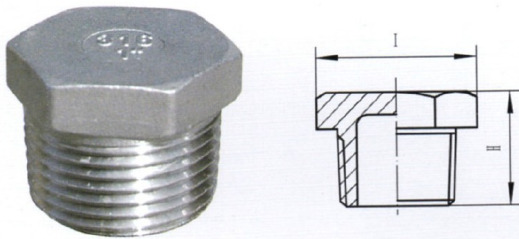

SIZE	1/8"	1/4"	3/8"	1/2"	3/4"	1"	1 1/4"	1 1/2"	2"	2 1/2"	3"	4"
I	17	17	18	22	28	35	44	50	62	79	92	118
H	17.5	17.5	18.5	22	22	25	29	29	33.5	42	44.5	49

SQUARE PLUG

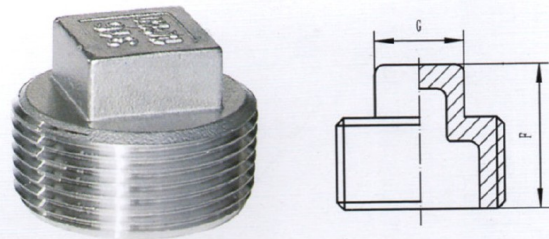

SIZE	1/8"	1/4"	3/8"	1/2"	3/4"	1"	1 1/4"	1 1/2"	2"	2 1/2"	3"	4"
G	6.6	9	12	16	19	23	26	32	40	45	58	
F	20.5	19	18	21	24	27	30	33	38	44	47.5	54

HOSE NIPPLE (HON)

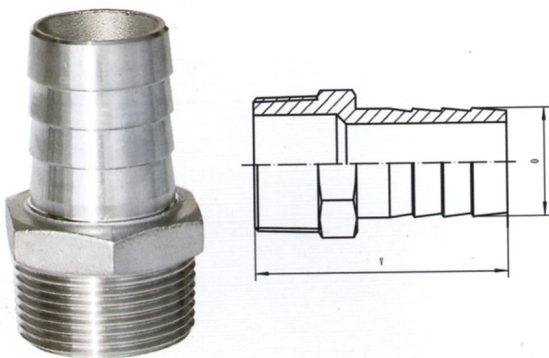

SIZE	1/8"	1/4"	3/8"	1/2"	3/4"	1"	1 1/4"	1 1/2"	2"	2 1/2"	3"	4"
O	7	9	11	13	20	25	33	39	51	65	77.5	103
V	35.5	46	47.5	60	63	70	73	88	92	109	123.5	128

HOSE NIPPLE (HON-F)

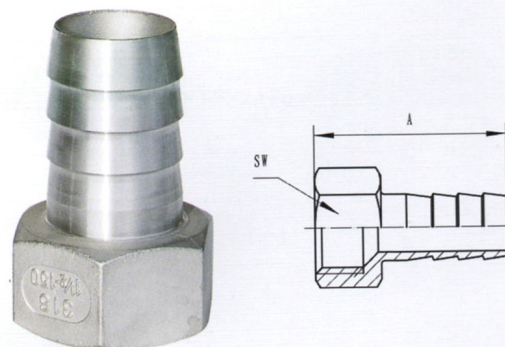

SIZE	1/8"	1/4"	3/8"	1/2"	3/4"	1"	1 1/4"	1 1/2"	2"	2 1/2"	3"	4"
A	40	42.5	47	62	58	66.5	69	87.5	90.5			
SW	15.5	19	21.5	27	31.5	38	47.5	55.5	66			

PIPE WELDING NIPPLE (WN)

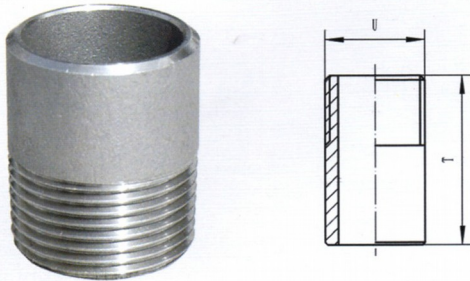

SIZE ITEM	1/8"	1/4"	3/8"	1/2"	3/4"	1"	1 1/4"	1 1/2"	2"	2 1/2"	3"	4"
U	10	13.5	17	21.5	27	33.5	42.5	48.5	60.5	76	89	114.5
T	30	30	30	35	40	40	50	50	50	60	70	80

PIPE WELDING NIPPLE (BN)

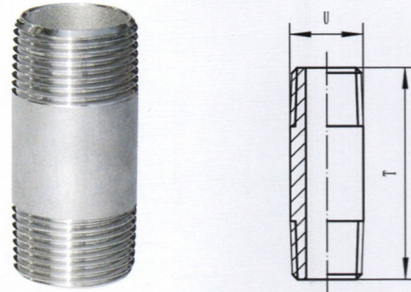

SIZE ITEM	1/8"	1/4"	3/8"	1/2"	3/4"	1"	1 1/4"	1 1/2"	2"	2 1/2"	3"	4"
U	10	13.5	17	21.5	27	33.5	42.5	48.5	60.5	76	89	114.5
T	40	40	40	60	60	60	80	80	100	100	120	120

PIPE THREADED HOSE NIPPLE (HON-M)

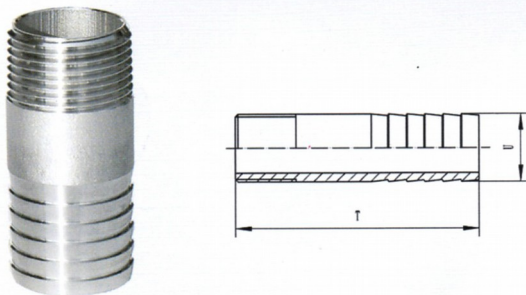

SIZE ITEM	1/8"	1/4"	3/8"	1/2"	3/4"	1"	1 1/4"	1 1/2"	2"	2 1/2"	3"	4"
U		13	17	21	26	33	42	48	60			
T		70	70	70	70	70	70	100	100			

PIPE BUTTWELDING HOSE NIPPLE (HON-BW)

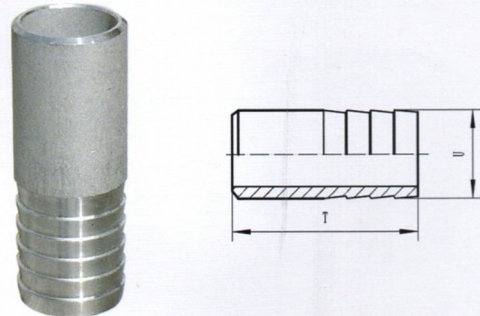

SIZE ITEM	1/8"	1/4"	3/8"	1/2"	3/4"	1"	1 1/4"	1 1/2"	2"	2 1/2"	3"	4"
U	10	13	17	21	26	33	42	48	60	75	88.5	114
T	30	30	35	40	40	45	55	55	60	80	100	120

RUNNING NIPPLE (TN)

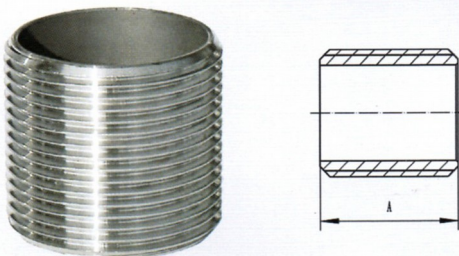

SIZE ITEM	1/8"	1/4"	3/8"	1/2"	3/4"	1"	1 1/4"	1 1/2"	2"	2 1/2"	3"	4"
A	16	18	22	25	30	35	38	38	45	55	60	70

CLOSE NIPPLE (TN)

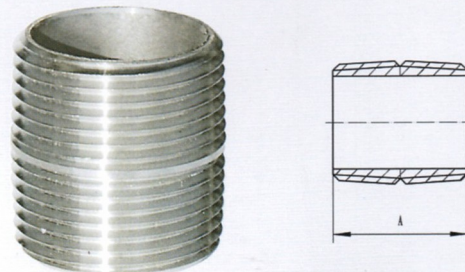

SIZE ITEM	1/8"	1/4"	3/8"	1/2"	3/4"	1"	1 1/4"	1 1/2"	2"	2 1/2"	3"	4"
A	16	18	22	25	30	35	38	38	45	55	60	70

ELBOW UNION F/F (CULB FF)

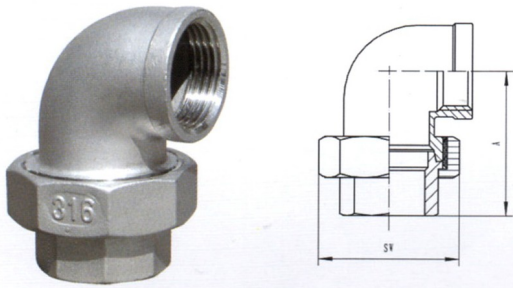

SIZE	1/8"	1/4"	3/8"	1/2"	3/4"	1"	1 1/4"	1 1/2"	2"	2 1/2"	3"	4"
A			45	49	49.5	62.5	66.5	78	91.5			
SW			34	37.5	44.5	53.5	64	71.5	85.5			

ELBOW UNION M/F (CULB MF)

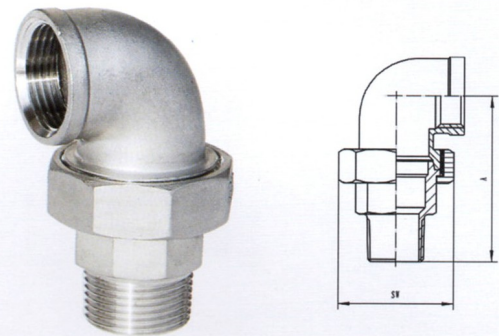

SIZE	1/8"	1/4"	3/8"	1/2"	3/4"	1"	1 1/4"	1 1/2"	2"	2 1/2"	3"	4"
A			58	64	66.5	81.5	87.5	101	117.5			
SW			34	37.5	44.5	53.5	64	71.5	85.5			

SOCKET PLAINS (SPU)

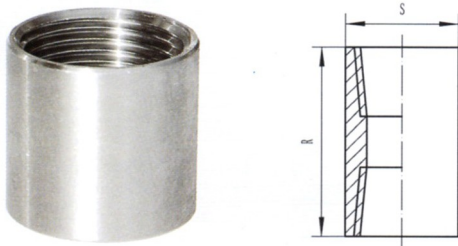

SIZE	1/8"	1/4"	3/8"	1/2"	3/4"	1"	1 1/4"	1 1/2"	2"	2 1/2"	3"	4"
S	13	16.5	20	24	30	37	46	52	64.5	81	94	121
R	17	24	25	28.5	31.5	36.5	40.5	40.5	49.5	58	63	74

SOCKET PLAIN (SPE)

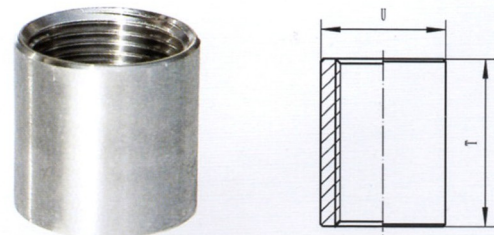

SIZE	1/8"	1/4"	3/8"	1/2"	3/4"	1"	1 1/4"	1 1/2"	2"	2 1/2"	3"	4"
U	13	16.5	20	24	30	37	45.5	52	64	81.5	93.5	120
T	17	24	25	27	31	34	38	38	46	58	61	71

SOCKET O.D. MACHINED (1/2 SPU)

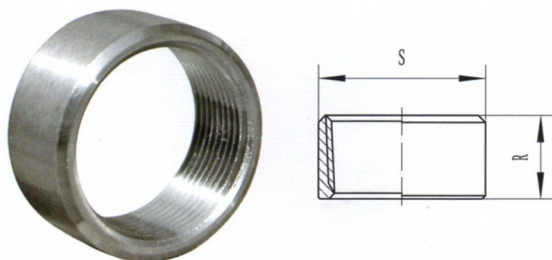

SIZE	1/8"	1/4"	3/8"	1/2"	3/4"	1"	1 1/4"	1 1/2"	2"	2 1/2"	3"	4"
S	14.5	17.5	20	24	30	38.5	48.5	52.5	65	81	94	121
R	8.5	11	12	14.5	15	19.5	22	22	25	27.5	30	35.5

SOCKET O.D. MACHINED (1/2 SPE)

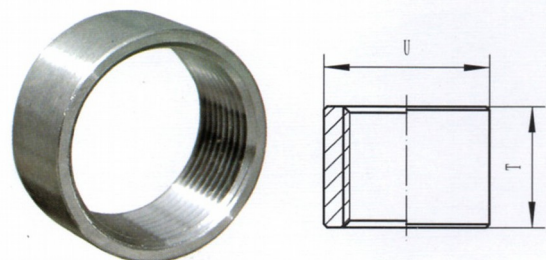

SIZE	1/8"	1/4"	3/8"	1/2"	3/4"	1"	1 1/4"	1 1/2"	2"	2 1/2"	3"	4"
U	14.5	17	20	25	30	37	46.5	52	64.5	81	94.5	121.5
T	7.9	10.5	12	15	16	19.5	22	22	26	30	32	38

### CAP (CB)

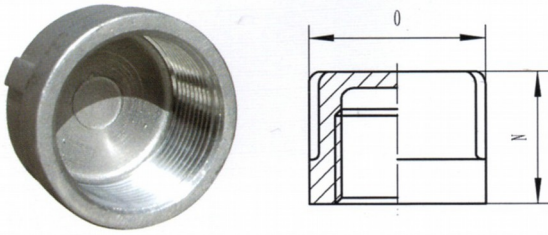

SIZE ITEM	1/8"	1/4"	3/8"	1/2"	3/4"	1"	1 1/4"	1 1/2"	2"	2 1/2"	3"	4"
N	13.5	15.5	18.0	18.5	20	24	27.0	29.0	36	41.0	43.5	47
O	16.5	20.0	23.5	27.5	34.0	42	51.0	56.5	68	84.5	98.5	124

### HEXAGON HEAD CAP (HCB)

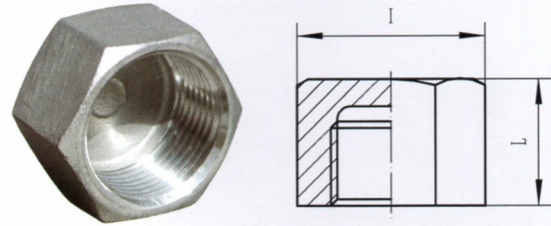

SIZE ITEM	1/8"	1/4"	3/8"	1/2"	3/4"	1"	1 1/4"	1 1/2"	2"	2 1/2"	3"	4"
I	14.5	18.5	21.5	25.5	31.5	38.5	47.5	53.5	66	82.5	96	121
L	13.5	15.5	18	18.5	20	24	27	29	35.5	41	43.5	47

### SOCKET BANDED (SB)

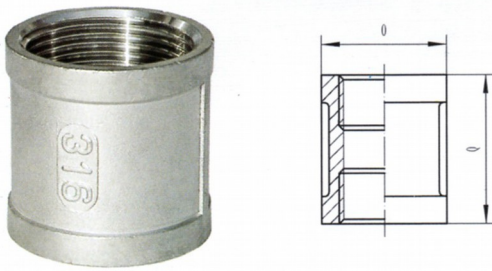

SIZE ITEM	1/8"	1/4"	3/8"	1/2"	3/4"	1"	1 1/4"	1 1/2"	2"	2 1/2"	3"	4"
O	13	20	23	26.5	32.5	40	49	55	68	84	97.5	121
Q	17	26	29	32.0	34	42	48	50	58	64	70	74

### REDUCER SOCKET BANDED (RSB)

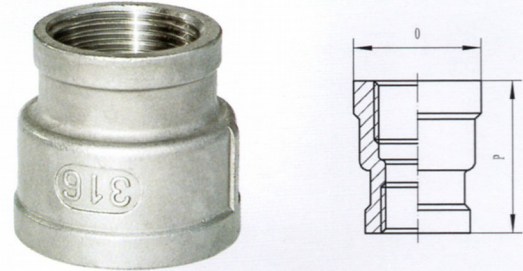

SIZE ITEM	1/8"	1/4"	3/8"	1/2"	3/4"	1"	1 1/4"	1 1/2"	2"	2 1/2"	3"	4"
O		18.5	22	26.5	32.5	40	49	55	68	84	97.5	124
P		25	29	31.5	33	38	45	49	54	61	67	76

### HEX NUT (LN)

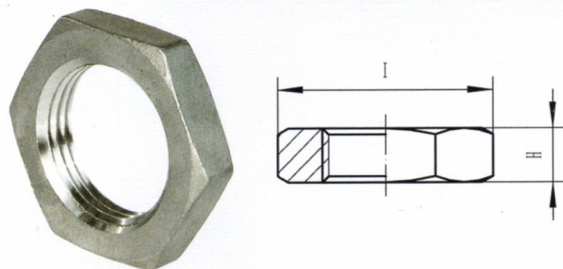

SIZE ITEM	1/8"	1/4"	3/8"	1/2"	3/4"	1"	1 1/4"	1 1/2"	2"	2 1/2"	3"	4"
I	17	19	24	24.5	30	37.5	46.5	53	65.5	82	95.5	121.5
H	7	7.5	7.5	8.5	10	10.5	11.5	12.5	14	17	20	23

### HEXAGON BUSHING (HB)

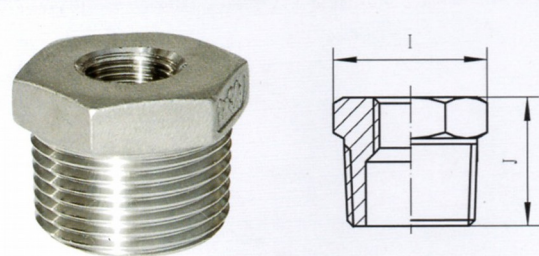

SIZE ITEM	1/8"	1/4"	3/8"	1/2"	3/4"	1"	1 1/4"	1 1/2"	2"	2 1/2"	3"	4"
I		14.5	18	22.5	28	35	44	50	62	79	92	118
J		17	18.5	21.5	25	28	31	33	37	42	44.5	48

TEE 9TB)

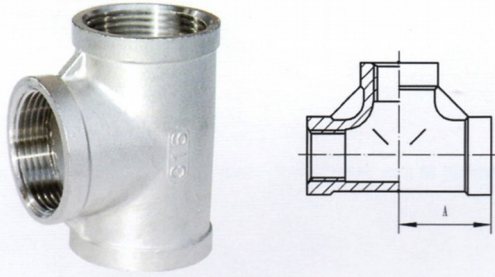

SIZE ITEM	1/8"	1/4"	3/8"	1/2"	3/4"	1"	1 1/4"	1 1/2"	2"	2 1/2"	3"	4"
A	17	19	22	25	28.5	34	40.5	45	54	67	79.5	99.5

REDUCER TEE (RTB)

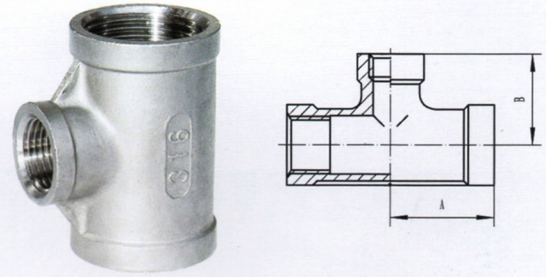

SIZE ITEM	1/8"	1/4"	3/8"	1/2"	3/4"	1"	1 1/4"	1 1/2"	2"	2 1/2"	3"	4"
A	19.5	23.5	24	42	34	37	44	51.5				
B	19.5	23.5	26	30.5	36	39.5	46.5	55.5				

90 ELBOW (90LB)

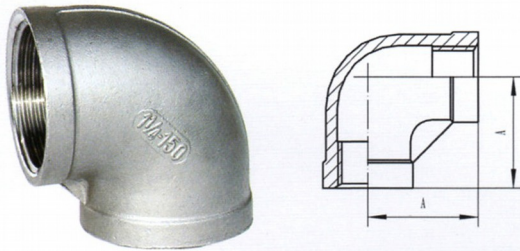

SIZE ITEM	1/8"	1/4"	3/8"	1/2"	3/4"	1"	1 1/4"	1 1/2"	2"	2 1/2"	3"	4"
A	17	19	22	25	28.5	34	40.5	45	54	67	79.5	99.5

REDUCED ELBOW

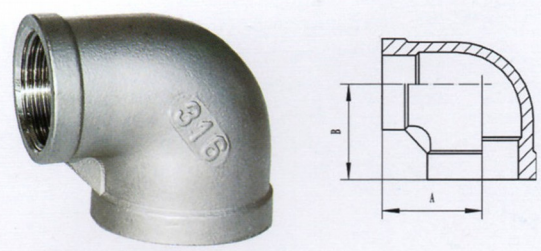

SIZE ITEM	1/8"	1/4"	3/8"	1/2"	3/4"	1"	1 1/4"	1 1/2"	2"	2 1/2"	3"	4"
A	16	21	26	29	36	40	47	54.5				
B		19	20	25.5	29	32	37	44.5	48.5			

45 ELBOW (45LB)

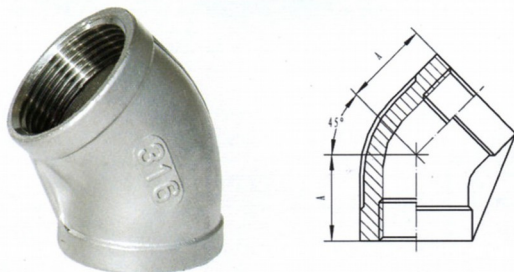

SIZE ITEM	1/8"	1/4"	3/8"	1/2"	3/4"	1"	1 1/4"	1 1/2"	2"	2 1/2"	3"	4"
A	17.5	18.5	20.5	22.5	25	28	32	36.5	42	47	52	63

CROSS (+B)

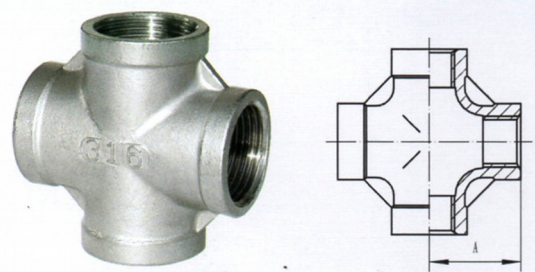

SIZE ITEM	1/8"	1/4"	3/8"	1/2"	3/4"	1"	1 1/4"	1 1/2"	2"	2 1/2"	3"	4"
A	17	19	23	27	31.5	36.5	42.5	47.5	56	67	77.5	93.5

**STREET ELBOW (SLB)**

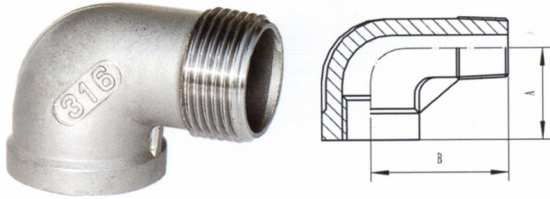

SIZE ITEM	1/8"	1/4"	3/8"	1/2"	3/4"	1"	1 1/4"	1 1/2"	2"	2 1/2"	3"	4"
A	15.5	17.5	20.5	23.5	27	31	37	41	51.5	62.5	79.5	100.5
B	23	27	30	36	41	48	54.5	60	73	87	106.5	126.5

**45 STREET ELBOW (SLB 45)**

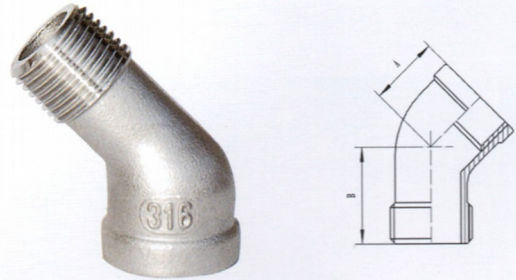

SIZE ITEM	1/8"	1/4"	3/8"	1/2"	3/4"	1"	1 1/4"	1 1/2"	2"	2 1/2"	3"	4"
A	15	17	19	20	24	29	33	39	45	46	48	52
B	21	28	29	30	40	40	37	33	42	75	88	108

**UNION F/F (CU FF)**

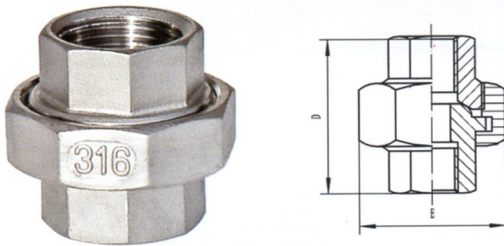

SIZE ITEM	1/8"	1/4"	3/8"	1/2"	3/4"	1"	1 1/4"	1 1/2"	2"	2 1/2"	3"	4"
D	32	32.5	35	38.0	41	49.5	51	57	63	71.5	80	91.5
E	29	29	34	37.5	44.5	53.5	64	71.5	85.5	108.5	123.5	153.5

**UNION M/F (CU MF)**

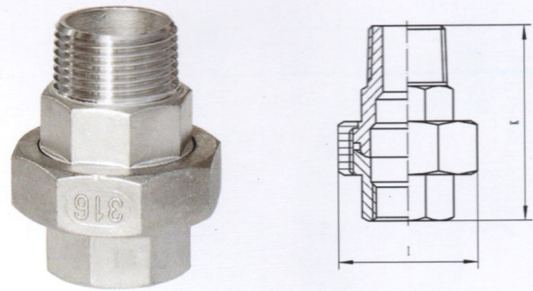

SIZE ITEM	1/8"	1/4"	3/8"	1/2"	3/4"	1"	1 1/4"	1 1/2"	2"	2 1/2"	3"	4"
I	29	29	34	37.5	44.5	53.5	64	71.5	85.5			
K	39.5	45	48	53.0	58	69	72	80	89			

**UNION M/M (CU MM)**

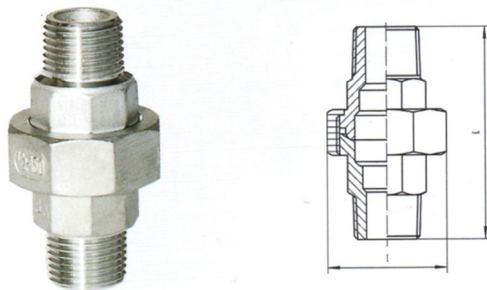

SIZE ITEM	1/8"	1/4"	3/8"	1/2"	3/4"	1"	1 1/4"	1 1/2"	2"	2 1/2"	3"	4"
I	29	29	34	37.5	44.5	53.5	64	71.5	85.5			
K	52	55.5	60.5	66	72.5	84.5	90	99	110			

**UNION BW/BW (CU BW)**

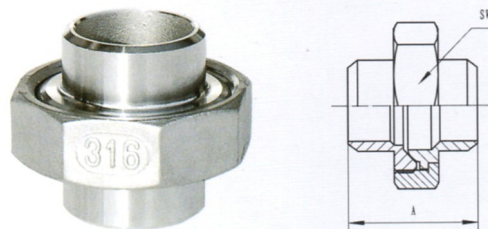

SIZE ITEM	1/8"	1/4"	3/8"	1/2"	3/4"	1"	1 1/4"	1 1/2"	2"	2 1/2"	3"	4"
A	40	38	38.5	40	41	47	48.5	51	56.5	89	103	107.5
SW	29	29	34	37.5	44.5	53.5	64	71.5	85.5	108.5	123.5	153.5

### TYPE A CAMLOCK COUPLING

Male Adapter X Female Thread

SS316

SS304



SIZE	N.W. (KGS)	PART#1	PART#2
1/2"	0.064	A050-SS	A050-SS304
3/4"	0.081	A075-SS	A075-SS304
1"	0.113	A100-SS	A100-SS304
1-1/4"	0.188	A125-SS	A125-SS304
1-1/2"	0.252	A150-SS	A150-SS304
2"	0.344	A200-SS	A200-SS304
2-1/2"	0.520	A250-SS	A250-SS304
3"	0.754	A300-SS	A300-SS304
4"	1.253	A400-SS	A400-SS304
5"	2.401	A500-SS	A500-SS304
6"	3.623	A600-SS	A600-SS304

### TYPE B CAMLOCK COUPLING

Female Coupler X Male Thread

SS316

SS304



SIZE	N.W. (KGS)	PART#1	PART#2
1/2"	0.147	B050-SS	B050-SS304
3/4"	0.161	B075-SS	B075-SS304
1"	0.248	B100-SS	B100-SS304
1-1/4"	0.324	B125-SS	B125-SS304
1-1/2"	0.422	B150-SS	B150-SS304
2"	0.55	B200-SS	B200-SS304
2-1/2"	0.714	B250-SS	B250-SS304
3"	1.053	B300-SS	B300-SS304
4"	1.362	B400-SS	B400-SS304
5"	3.032	B500-SS	B500-SS304
6"	3.815	B600-SS	B600-SS304

### TYPE B SELF-LOCKING CAMLOCK

Type B With Self-locking Handles

SS316

SS304



SIZE	PART#1	PART#2
1"	SLB100-SS	SLB100-SS304
1-1/4"	SLB125-SS	SLB125-SS304
1-1/2"	SLB150-SS	SLB150-SS304
2"	SLB200-SS	SLB200-SS304
2-1/2"	SLB250-SS	SLB250-SS304
3"	SLB300-SS	SLB300-SS304
4"	SLB400-SS	SLB400-SS304

### TYPE C SELF-LOCKING CAMLOCK

Type C With Self-locking Handles

SS316

SS304



SIZE	PART#1	PART#2
1"	SLC100-SS	SLC100-SS304
1-1/4"	SLC125-SS	SLC125-SS304
1-1/2"	SLC150-SS	SLC150-SS304
2"	SLC200-SS	SLC200-SS304
2-1/2"	SLC250-SS	SLC250-SS304
3"	SLC300-SS	SLC300-SS304
4"	SLC400-SS	SLC400-SS304

### TYPE D SELFLOCKING CAMLOCK

Type D With Self-locking Handles

SS316

SS304



SIZE	PART#1	PART#2
1"	SLD100-SS	SLD100-SS304
1-1/4"	SLD125-SS	SLD125-SS304
1-1/2"	SLD150-SS	SLD150-SS304
2"	SLD200-SS	SLD200-SS304
2-1/2"	SLD250-SS	SLD250-SS304
3"	SLD300-SS	SLD300-SS304
4"	SLD400-SS	SLD400-SS304

### TYPE DC SELF-LOCKING HANDLES

Type DC With Self-locking Handles

SS316

SS304



SIZE	PART#1	PART#2
1"	SLDC100-SS	SLDC100-SS304
1-1/4"	SLDC125-SS	SLDC125-SS304
1-1/2"	SLDC150-SS	SLDC150-SS304
2"	SLDC200-SS	SLDC200-SS304
2-1/2"	SLDC250-SS	SLDC250-SS304
3"	SLDC300-SS	SLDC300-SS304
4"	SLDC400-SS	SLDC400-SS304

### STAINLESS STEELCAMLOCK COUPLING

#### STAINLESS STEEL CAMLOCK COUPLING

Femal Coupler X Hose Shank

SS316

SS304



SIZE	N.W. (KGS)	PART#1	PART#2
1/2"	0.163	C050-SS	C050-SS304
3/4"	0.185	C075-SS	C075-SS304
1"	0.261	C100-SS	C100-SS304
1-1/4"	0.375	C125-SS	C125-SS304
1-1/2"	0.462	C150-SS	C150-SS304
2"	0.737	C200-SS	C200-SS304
2-1/2"	0.908	C250-SS	C250-SS304
3"	1.309	C300-SS	C300-SS304
4"	1.989	C400-SS	C400-SS304
5"	3.523	C500-SS	C500-SS304
6"	5.028	C600-SS	C600-SS304





### STAINLESS STEEL CAMLOCK COUPLING

#### STAINLESS STEEL CAMLOCK COUPLING

Female Coupler X Female Thread



			SS316	SS304
SIZE	N.W. (KGS)	PART#1	PART#1	PART#2
1/2"	0.164	D050-SS	D050-SS304	D050-SS304
3/4"	0.170	D075-SS	D075-SS304	D075-SS304
1"	0.253	D100-SS	D100-SS304	D100-SS304
1-1/4"	0.325	D125-SS	D125-SS304	D125-SS304
1-1/2"	0.427	D150-SS	D150-SS304	D150-SS304
2"	0.601	D200-SS	D200-SS304	D200-SS304
2-1/2"	0.793	D250-SS	D250-SS304	D250-SS304
3"	1.014	D300-SS	D300-SS304	D300-SS304
4"	1.570	D400-SS	D400-SS304	D400-SS304
5"	4.021	D500-SS	D500-SS304	D500-SS304
6"	5.452	D600-SS	D600-SS304	D600-SS304

### STAINLESS STEEL CAMLOCK COUPLING

#### STAINLESS STEEL CAMLOCK COUPLING

Male Adapter X Hose Shank



			SS316	SS304
SIZE	N.W. (KGS)	PART#1	PART#1	PART#2
1/2"	0.073	E050-SS	E050-SS304	E050-SS304
3/4"	0.110	E075-SS	E075-SS304	E075-SS304
1"	0.150	E100-SS	E100-SS304	E100-SS304
1-1/4"	0.269	E125-SS	E125-SS304	E125-SS304
1-1/2"	0.350	E150-SS	E150-SS304	E150-SS304
2"	0.597	E200-SS	E200-SS304	E200-SS304
2-1/2"	0.795	E250-SS	E250-SS304	E250-SS304
3"	1.180	E300-SS	E300-SS304	E300-SS304
4"	2.130	E400-SS	E400-SS304	E400-SS304
5"	3.124	E500-SS	E500-SS304	E500-SS304
6"	4.228	E600-SS	E600-SS304	E600-SS304

#### STAINLESS STEEL CAMLOCK COUPLING

Male Adapter X Male Thread



			SS316	SS304
SIZE	N.W. (KGS)	PART#1	PART#1	PART#2
1/2"	0.076	F050-SS	F050-SS304	F050-SS304
3/4"	0.090	F075-SS	F075-SS304	F075-SS304
1"	0.130	F100-SS	F100-SS304	F100-SS304
1-1/4"	0.222	F125-SS	F125-SS304	F125-SS304
1-1/2"	0.301	F150-SS	F150-SS304	F150-SS304
2"	0.486	F200-SS	F200-SS304	F200-SS304
2-1/2"	0.564	F250-SS	F250-SS304	F250-SS304
3"	1.057	F300-SS	F300-SS304	F300-SS304
4"	1.320	F400-SS	F400-SS304	F400-SS304
5"	2.909	F500-SS	F500-SS304	F500-SS304
6"	5.127	F600-SS	F600-SS304	F600-SS304